



**Flammable, toxic and oxygen deficiency gas detector using catalytic, electrochemical cell and infrared sensors.**

# Sensepoint XCD

## Common transmitter platform

- Same transmitter structure applicable to a variety of new and existing gas sensors
- Local/remote sensor capability
- Uses ECC/Catalytic/IR sensing technology
- Smart intelligence recognises sensor type & range

## Clear and informative display

- Tri-colour backlight on LCD display
- Instantly and clearly visible from a distance
- Helps to clarify operation status in adverse situations

## Multiple signal outputs

- 4 to 20mA standard
- Switching relays
- Modbus RTU

## Surecell™ and Reflex™

- Superior performance sensing technology
- Increased accuracy and reliability
- Determines the health of O2 and toxic cells
- Detects "dry-out" of the sensor cell
- Ensures highest level of "up-time"

## Infrared sensing technology

- Low cost IR solution
- Longer service life
- No poisons
- Doesn't need oxygen

## Non-intrusive operation

- Easy routine maintenance
- No need to open the transmitter
- Faster planned maintenance
- Greater operator confidence

## Housing material options

- LM25 Aluminium Alloy
- Stainless Steel 316

## Easy to install

- Simple plug-in sensors
- Integral plate for wall mount
- Separate kit for vertical/horizontal pipe mount
- On board relays allow for local alarms
- 3 wire operation, source or sink
- Option remote sensor mounting
- Option Modbus communications for remote diagnostics/Configuration

## Worldwide certifications

- IEC, ATEX
- UL, CSA
- KTL, GB



The Sensepoint XCD (Exceed) range of fixed gas detectors is used to monitor areas where flammable, oxygen deficiency and toxic gases may pose a hazard to working environments. Incorporating all the advantages of leading edge, fixed industrial gas detection technology, XCD offers high performance and reliability synonymous with the Honeywell brand. XCD is designed for a broad spectrum of industrial applications with a comprehensive choice of features and benefits in a truly cost effective package.

There are three different versions of Sensepoint XCD, They are STD, RTD and RFD version. The STD (Standard) version is used with standard plug-in sensor. The RTD (Remote Toxic Detector) is used with Sensepoint Toxic sensors that can be locally or remotely mounted. The RFD (Remote Flammable Detector) version is used with Sensepoint Flammable sensors (Including High Temperature Version) that can be locally or remotely mounted.

Sensepoint XCD uses a number of patented sensing technologies in its core design which reflect over 50 years of global experience associated with the famous Sieger name. These include poison resistant catalytic bead for flammable gases and electrochemical cell for toxic gases. Non-dispersed Infrared (NDIR) technology is available to those users who require more robust detection with longer sensor operating lifetime.

As a result, XCD is suitable for many light and heavy industries. In addition, the design of XCD reflects outstanding performance, whether it is used in harsh outdoor environments or sheltered indoor applications.

# Ordering Information

## 1. Sensepoint XCD-STD Transmitter (with Standard Flammable and Primary Toxic Sensor Cartridge)

Standard Supply: A Sensepoint XCD KIT consists of Transmitter, Sensor socket, Sensor cartridge, Standard weather protection, Magnetic wand and Allen key.

## 2. Sensepoint XCD-RTD transmitter (use with oxygen and toxic Sensepoint sensors)

Standard Supply: Sensepoint XCD-RTD (Remote Toxic Detector) allows for a gas sensor from a wider selection of 2-wire 4 to 20 mA input type Toxic and Oxygen sensors to be fitted directly to the transmitter housing, or wired remotely from another location. KIT includes Transmitter, Magnetic Wand and Allen Key.

## 3. Sensepoint XCD-RFD transmitter (use with flammable Sensepoint sensors)

Standard Supply: Sensepoint XCD-RFD (Remote Flammable Detector) allows for remotely mounted flammable gas detectors such as Hi-Temperature version of Sensepoint Flammable to be located in adverse applications and monitored from a convenient location. KIT includes Transmitter, Magnetic Wand and Allen Key.

## 4. ACCESSORIES

S3KCAL	Calibration cap
SPXCDC	Collecting cone for use with lighter than air gases
SPXCDDMK	Duct mounting kit
SPXCMTBR	Mounting bracket (inc. bolts, nuts, brackets)
SPXCSDP	Sunshade / Deluge Protection
SPXCDHMANEN	Hard Copy XCD STD Manual in English
SPXCDHMANCN	Hard Copy XCD STD Manual in Chinese
SPXCDHMANKR	Hard Copy XCD STD Manual in Korean
SPXCDHMRTEN	Hard Copy XCD RTD Manual in English
SPXCDHMRFEN	Hard Copy XCD RFD Manual in English
SPXCMMADP	Gland Thread Adaptor, M25 male to M20 female, certified

## 5. Spares

SPXCDWP	Sensepoint XCD Standard Weather Protection
SPXCDSRLS	Sensor Retainer with locking screw
SPXCDAKS	Allen key for stopper
SPXCDHWES	Hex wrench for earth screw
SPXCDEBS	Earth Bracket and Screws
SPXCDMAG	Magnetic wand

## Applications

- Petrochemical plants
- Offshore exploration and production
- Natural gas distribution
- Gas & Petroleum storage
- Food & Beverage
- Oil refineries
- Power generation plants
- Steel plants
- Plant rooms and factories
- Refrigeration
- Chemical manufacturing
- Fertilizer manufacturing
- Waste water facilities
- Chemical stores
- Vehicle manufacturing

<b>ENCLOSURE MATERIAL</b> L LM25 S SS316	<b>GAS RANGE</b> X User Adjustable 1 Fixed	<b>MODBUS OPTION</b> None without MODBUS M with MODBUS	<b>GAS TYPE</b> F Flammable Catalytic Bead R Methane IR (%LEL) P Propane IR (%LEL) O Oxygen H Hydrogen Sulphide C Carbon Monoxide G Hydrogen N Nitrogen Dioxide V Flammable IR (%Vol) B Carbon Dioxide IR
<b>SPXCD A L M F X M</b>			
<b>STANDARDS</b> A ATEX/IECEX/KTL/PA & GB U UL/CSA	<b>CABLE ENTRY</b> M M20 N 3/4"NPT		

<b>ENCLOSURE MATERIAL</b> L LM25 S SS316	<b>MODBUS OPTION *</b> None without MODBUS M with MODBUS	<b>Note:</b> Refer to the Sensepoint datasheet for a range of Sensepoint Toxic sensors that may be fitted directly to the 4-20mA input XCD RTD transmitter
<b>SPXCD A L M TX4 M</b>		
<b>STANDARDS</b> A ATEX/IECEX/KTL/PA & GB U UL/CSA	<b>CABLE ENTRY</b> M M20	

<b>ENCLOSURE MATERIAL</b> L LM25 S SS316	<b>MODBUS OPTION *</b> None without MODBUS M with MODBUS
<b>SPXCD A L M RFD M</b>	
<b>STANDARDS</b> A ATEX/IECEX/KTL/PA & GB U UL/CSA	<b>CABLE ENTRY</b> M M20



### XCD Common Transmitter Platform

The Sensepoint XCD-STD uses ECC/Catalytic/IR and remote sensing technology, which are supplied pre-configured. Smart intelligence in the transmitter detects the type and range of sensor fitted.

<p><b>STD</b></p> <p>CAT Bead Sensor: Flammable Gas</p> <p>IR Sensor: Methane, Propane, CO<sub>2</sub></p> <p>ECC Sensor: O<sub>2</sub>, CO, H<sub>2</sub>S, H<sub>2</sub>, NO<sub>2</sub></p>	<p><b>RTD</b></p> <p>Sensepoint Toxic:</p> <p>SO<sub>2</sub>, NH<sub>3</sub>, NO, NO<sub>2</sub>, Cl<sub>2</sub></p>	<p><b>RFD</b></p> <p>Sensepoint STD, Sensepoint HT, CAT Bead*, IR Methane, IR Propane*, IR CO<sub>2</sub>*</p>
--	--	--

\*: Please contact Honeywell Analytics for Availability

\*\* : All Sensepoint Toxic sensors, plus other sensors with 2wire 4-20mA output.

# Specification



Sensepoint XCD Transmitter		
<b>Use</b>	3-wire, 4-20mA, gas detector transmitter for use with directly installed flammable and toxic gas sensors. For the protection of personnel and plant from flammable and toxic gas hazards.	
<b>Electrical</b>	Input Voltage Range: STD&RFD: 16 to 32Vdc (24Vdc nominal), RTD: 18 to 32Vdc (24Vdc nominal)	
	Power Consumption: ECC = 3.7W, IR = 3.7W, Cat = 4.9W	
	Current output	
	≥0.0<1.0 mA	Fault
	4.0 mA to 20.0 mA	Normal gas measurement
	2.0 mA or 4.0 mA (17.4 mA)	Inhibit (during configuration/user settings)
	22.0 mA	Maximum over range
	Terminals	15 (STD), 18(RTD&RFD) x screw terminals suitable for wire diameter 0.5mm <sup>2</sup> (20AWG) to 2.5mm <sup>2</sup> (13AWG)
Relays	3 x 5A@250VAC. Selectable normally open or normally closed (Terminal) and energized/de-energized (programmable)	
Communication	RS485 Modbus RTU	
Construction		
<b>Transmitter Material</b>	Epoxy painted LM25 Aluminium. Stainless Steel 316	
<b>Sensor Material</b>	Stainless Steel 316	
<b>Weight</b>	LM25 Aluminium Alloy :2.4kg. Stainless Steel 316: 4.5 kg	
<b>Mounting</b>	Pole or wall mounting	
<b>Entries</b>	2 x M20 (or 2 x ¾"NPT) field cable entries, 1 x M25 sensor entry	
Performance		
<b>Repeatability</b>	+/- 1% of FSD	
<b>Linearity</b>	+/- 1% of FSD	
<b>Accuracy</b>	< +/- 5% of FSD (O2, CO, H2S, FL-CAT)	
<b>Response Time</b>	T50 = <15s, T90= <30s (FL CAT and IR sensors)	
Detectable Gases		

## XCD STD

Gas Name	Selectable Span Gas Range(s):	Step	Default Range	Acceptable Calibration Gas Range(s)
Oxygen	25.0%/Vol only	n/a	25.0%/Vol	20.9%/Vol(Fixed)
Hydrogen Sulphide	10.0 to 100.0ppm	1ppm	50ppm	30 to 70% of selected
Carbon Monoxide	100 to 1000ppm	100ppm	500ppm	
Hydrogen	1,000ppm only	n/a	1,000ppm	
Nitrogen Dioxide	10 to 50ppm	5ppm	10ppm	30 to 70% of selected full scale range (Typically 50%)
Methane (CAT)	20,0 to 100.0%LEL	10%LEL	100.0%LEL	
Methane (IR)	20,0 to 100.0%LEL	10%LEL	100.0%LEL	
Propane (IR)	20,0 to 100.0%LEL	10%LEL	100.0%LEL	
Carbon Dioxide (IR)	2.00%/Vol only	n/a	2.00%/Vol	0.8 to 1.2%/Vol

**NOTES:** Performance figures are taken at 20~25°C, measured using a sample humidity of 50%RH, applicable between 10 and 90% of full scale, measured by test units calibrated at 50% of full scale, measured at recommended flow rate with calibration cup (SP3KCAL). Response time (T90) may increase at lower temperature condition or at diffusion mode with weather protection (SPXCDWP). Data represents typical values, and system conditioning may be required to achieve stated result. Contact HA for details.

## XCD RTD (Supply with Sensepoint Toxic)

Gas Name	Selectable Gas Range(s):	Resolution	Default Range	Acceptable Calibration Gas Range:
Sulphur Dioxide	15ppm only	0.1	15.0ppm	10ppm
	50ppm only	0.1	50.0ppm	20ppm
Ammonia	50ppm only	0.1	50.0ppm	25ppm
	100ppm only	0.1	100ppm	50ppm
Chlorine	1000ppm only	1	1000ppm	500ppm
	5ppm only	0.01	5.00ppm	3ppm
Nitrogen Dioxide	15ppm only	0.1	15.0ppm	10ppm
	10ppm only	0.1	10.0ppm	5ppm
Nitrogen Monoxide	100ppm only	0.1	100.0ppm	50ppm

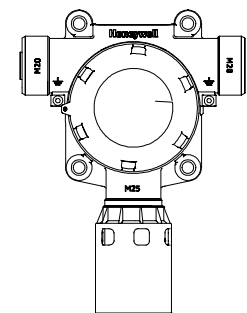

XCD STD

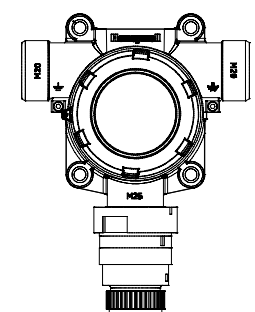

XCD RTD with in-situ Sensepoint Toxic sensor

<b>Hydrogen Sulphide</b>	20.0ppm only	0.1	100.0ppm	50ppm
	50.0ppm only	0.1	20.0ppm	10ppm
	100ppm only	0.1	50.0ppm	25ppm
<b>Carbon Monoxide</b>	100ppm only	1	100ppm	50ppm
	200ppm only	1	200ppm	50ppm
	500ppm only	1	500ppm	100ppm
<b>Hydrogen</b>	1000ppm only	1	1000ppm	500ppm
	9999ppm only	1	9999ppm	500ppm
<b>Oxygen</b>	25.0% V/V only	0.1	25.0% V/V	20.9% V/V

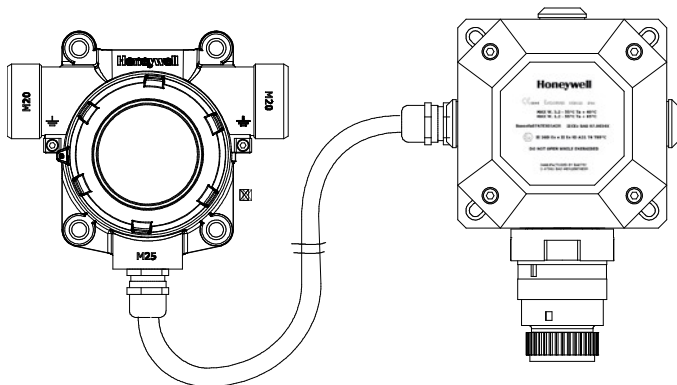

XCD RTD with Remotely installed sensor

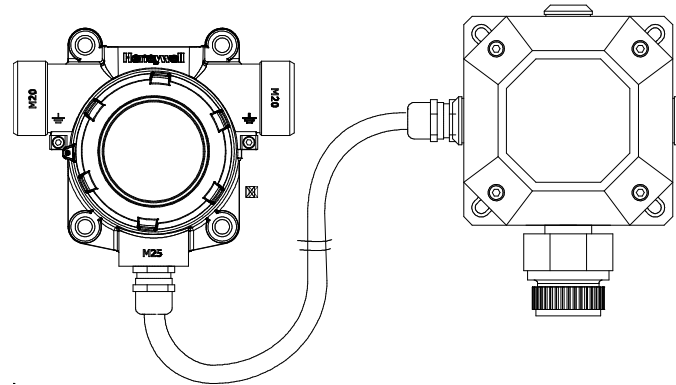

XCD RFD with Remotely installed sensor

**XCD RFD**

Gas Name	Selectable Gas Range(s)	Resolution	Default Range	Acceptable Calibration Gas Range
<b>Sensepoint Flammable</b>	100%LEL only	1%LEL	100%LEL	30 to 70%LEL
<b>Sensepoint HT Flammable</b>	100%LEL only	1%LEL	100%LEL	30 to 70%LEL
<b>Flammable CB*</b>	100%LEL only	1%LEL	100%LEL	30 to 70%LEL
<b>Methane IR</b>	100%LEL only	1%LEL	100%LEL	30 to 70%LEL
<b>Propane IR*</b>	100%LEL only	1%LEL	100%LEL	30 to 70%LEL
<b>Carbon Dioxide*</b>	2.00%Vol only	0.01%Vol	2.00%	30 to 70%FS

\*Contact Honeywell Analytics for availability

<b>Certification</b>	
<b>China</b>	GB Ex d IIC T4 GB3836.1&2 -2000, PA CCCF
<b>Korea</b>	KTL Ex d II C T6 (-40°C to +65°C)
<b>US</b>	UL - Class I, Division 1, Groups B, C and D, Class I, Division 2, Groups B, C & D, Class II, Division, Groups E, F & G, Class II, Division 2, Groups F & G. -40°C to +65°C
<b>Canadian</b>	cUL/CSA
<b>European</b>	ATEX Ex II 2 GD Ex d IIC Gb T6(Ta -40°C to +65°C) Ex tb IIIC T85°C Db IP66
<b>International</b>	IEC Ex d IIC Gb T6(Ta -40°C to +65°C) Ex tb IIIC T85°C Db IP66
<b>EMC</b>	EN50270:2006 EN6100-6-4:2007
<b>Environmental</b>	
<b>IP Rating</b>	IP66 in accordance with EN60529:1992
<b>Operating Temperature</b>	-40°C to +65°C/ -40°F to +149°F.
<b>Operating Humidity</b>	Continuous 20-90%RH (non condensing), Intermittent 10-99%RH (non condensing)
<b>Operating Pressure</b>	90-110kPa
<b>Storage Conditions</b>	-25°C to +65°C (-13°F to +149°F)

# Installation

## Outline Installation Dimensions

The Sensepoint XCD transmitter has an integral mounting plate consisting of four mounting holes on the transmitter body. The transmitter may be fixed directly to a surface mounting, or to a horizontal or vertical pipe/structure, 40.0-80.0mm (1.6 to 3.1") in diameter/cross section. The pipe mounting bracket accessory (optional) may be used for this purpose.

User cable entries shown (2 x M20) are for ATEX/IECEX version enclosures. UL/cUL versions have 2 x 3/4"NPT conduit entries. A suitable blanking plug is supplied which must be used to seal any unused entry. The blanking plug must be suitably sealed to maintain the IP rating of the detector.

Note: All dimensions in mm.



### Outline Installation Dimensions for XCD STD Version Locally Mounted

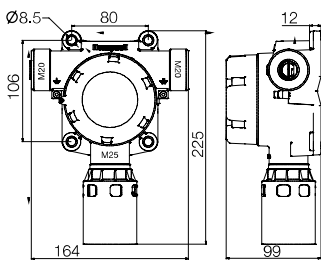

### Outline Installation Dimensions for XCD RTD Version Locally Mounted

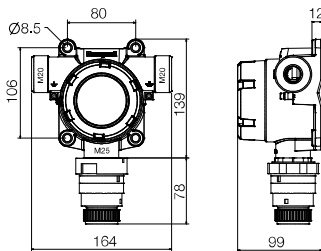

### Outline Installation Dimensions for XCD RFD Version

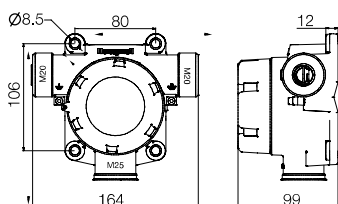

## Installation Options

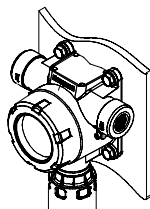

Wall Mounted

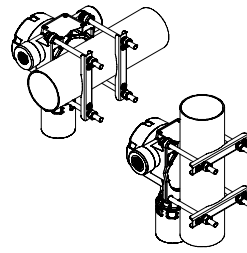

Vertical or horizontal pipe mounted  
(Using optional pipe mounting bracket)

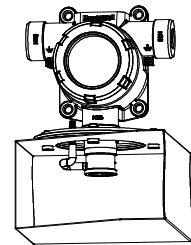

Duct Mounted

### Other Accessories

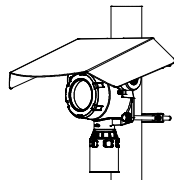

Sunshade/Deluge protection

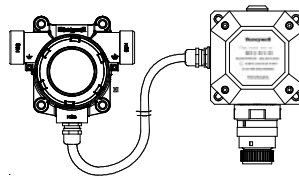

Remote Install Accessories for RTD

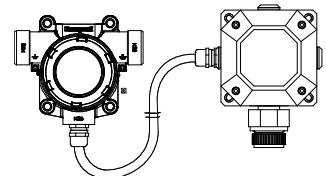

Remote Install Accessories for RFD

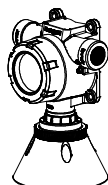

Collecting Cone

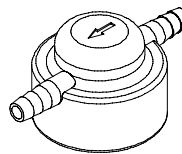

Gassing Cap

## Electrical

Sensepoint XCD is designed for use in potentially explosive atmospheres. As such, installation should follow national guidelines using suitable mechanically protected cable and glands or conduit. Use 0.5mm<sup>2</sup> (20AWG) to 2.5mm<sup>2</sup> (~13AWG) cross sectional area cable as needed to ensure minimum operating voltage at the detector, depending on installed cable length. Cable diameter should be selected to maintain the minimum required voltage for the longest installed cable length under maximum power.

## Wiring Schematics

The Sensepoint XCD transmitter may be wired in either Current Sink or Current Source configuration. These two options are offered to allow greater flexibility in the type of control system that it can be used with. Sink/Source is selectable via the switch located on the back side of the display module; accessible by removing the display module during installation/commissioning.

### Terminal Connections for XCD STD Version

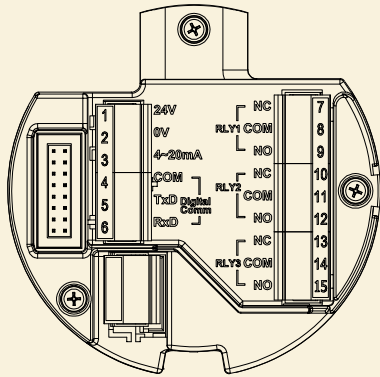

Terminal Module Connections				
Terminal Number	Marking	Connection	Description	
1	24V	+VE Supply(16-32VDC)	Controller Connections	
2	0V	-VE Supply(0VDC)		
3	4-20mA	Current Output Signal		
4	COM	Drain	MODBUS RTU, RS485 (Optional)	
5	TxD	MODBUS A(+)		
6	RxD	MODBUS A(-)		
7	RLY1/NC	Normally Closed	Programmable Relay 1 (Default A1)	
8	RLY1/COM	Common		
9	RLY1/NO	Normally Open		
10	RLY2/NC	Normally Closed	Programmable Relay 2 (Default A2)	
11	RLY2/COM	Common		
12	RLY2/NO	Normally Open		
13	RLY3/NC	Normally Closed	Programmable Relay 3 (Default Fault)	
14	RLY3/COM	Common		
15	RLY3/NO	Normally Open		

### Terminal Connections for XCD RTD Version

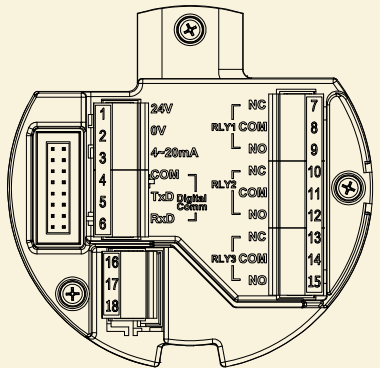

Terminal Module Connections				
Terminal Number	Marking	Connection	Description	
1	24V	+VE Supply(18-32VDC)	Controller Connections	
2	0V	-VE Supply(0VDC)		
3	4-20mA	Current Output Signal		
4	COM	Drain	MODBUS RTU, RS485 (Optional-Pending)	
5	TxD	MODBUS A(+)		
6	RxD	MODBUS A(-)		
7	RLY1/NC	Normally Closed	Programmable Relay 1 (Default A1)	
8	RLY1/COM	Common		
9	RLY1/NO	Normally Open		
10	RLY2/NC	Normally Closed	Programmable Relay 2 (Default A2)	
11	RLY2/COM	Common		
12	RLY2/NO	Normally Open		
13	RLY3/NC	Normally Closed	Programmable Relay 3 (Default Fault)	
14	RLY3/COM	Common		
15	RLY3/NO	Normally Open		
16	+VE(Red)	+24V DC	Sensor Connection for RTD	
17	-VE(Blue)	4-20mA		
18	Unused			

### Terminal Connections for XCD RFD Version

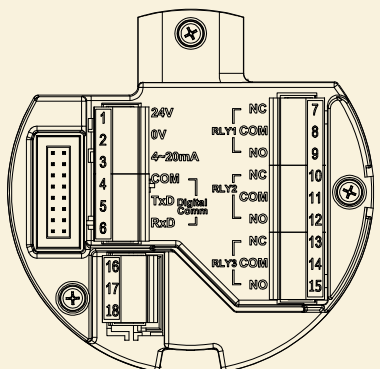

Terminal Module Connections				
Terminal Number	Marking	Connection	Description	
1	24V	+VE Supply(16-32VDC)	Controller Connections	
2	0V	-VE Supply(0VDC)		
3	4-20mA	Current Output Signal		
4	COM	Drain	MODBUS RTU, RS485 (Optional-Pending)	
5	TxD	MODBUS B (+)		
6	RxD	MODBUS A (-)		
7	RLY1/NC	Normally Closed	Programmable Relay 1 (Default A1)	
8	RLY1/COM	Common		
9	RLY1/NO	Normally Open		
10	RLY2/NC	Normally Closed	Programmable Relay 2 (Default A2)	
11	RLY2/COM	Common		
12	RLY2/NO	Normally Open		
13	RLY3/NC	Normally Closed	Programmable Relay 3 (Default Fault)	
14	RLY3/COM	Common		
15	RLY3/NO	Normally Open		
16	+VE	Brown(Sensor)	Sensor Connection for RFD	
17	-VE	Blue(Sensor)		
18	Signal	White(Sensor)		

### Controller to Transmitter

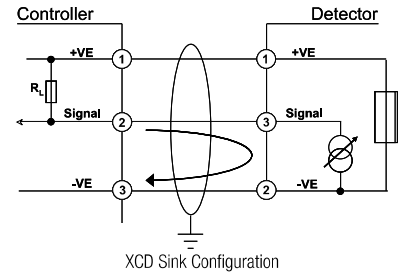
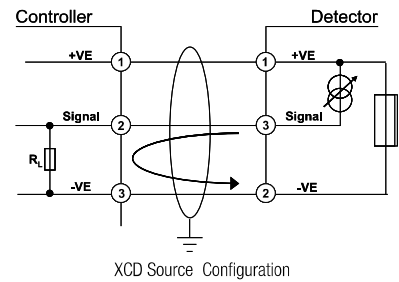

### Transmitter to Sensor for XCD RTD Version

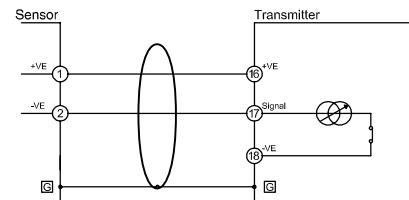

### Transmitter to Sensor for XCD RFD Version

