

LG Series Solar charge controller

LG60A Solar Charge Controller

User Manual



Dear user :

Many thanks for you choosing our product!
Please read the user instructions carefully before usage.

Attention

Warning : This controller is a high power device, please read the instruction before use, take extra care when operating.

Safety notes:

- ◆ Read the instruction and attention carefully before use
- ◆ Do not disassembly and repair the controller freely
- ◆ Avoid direct sunlight and pay attention to ventilation When installation
- ◆ Install appropriate fuse or circuit breaker on the outside of the controller
- ◆ Disconnect the external fuse or circuit breaker when wiring
- ◆ Be careful to prevent short-circuit when installing the battery
- ◆ To ensure adopt the correct wire diameter, connect firmly, fasten the wire after connection
- ◆ Temperature resistance should be fixed on the battery,the othe end connect to the controller

Product Introduction

This controller is designed for DC power supply system, small and medium-sized pv modules power system, using a dedicated computer chip to realize the intelligent control, all chips adopt industrial level, can be used in harsh environment. Meanwhile system offers specific indication for the charge, load , sorts of failure and various protections such as short circuit, over-load, over charge, particular anti-reversed polarity protection and so on, the controller used computer chip to sample the parameter of the battery voltage, photovoltaic cell voltage, discharge current and environment temperature. According to the battery' s character, realized the accurate control to discharge rate, correction of the temperature compensation through special control model calculation.charging with the intelligent PWM dim way and charging compensation in accordance with the current temperature of the battery, compensation factor is 3mv/°C/unit.LCM could show all of the parameters and modes. Dial switch need to adjust if adopting different voltage system.

Feature

1. The controller carried with LCM module which can display system status and parameters
2. Parameters of charge and discharge are adjustable
3. Begin to ascending charging automatically when the voltage of battery below the ascending charging recover voltage
4. Temperature compensation become more accurate due to Double temperature sensors design,inner temperature sensor test the inner temperature of the controller , outer temperature sensor test the outer temperature of the controller.
5. The controller could figure out everyday' s power of charge and discharge which make user assess the controller and entire system more easily
6. With the charging current overload protection function, the controller will reduce the charge current to protect the charging circuit after it surpass the rated current.
7. A equalizing charge every 30 days in order to prevent battery vulcanization
8. Industrial-grade chips and precision components makes the controller can operate in any harsh environment
9. Design of double MOS series control circuit and PWM dim control make the charging efficiency increased greatly
10. The setting parameter possess the saving function which makes the parameter won' t be erased after losing the electricity and system become more reliable.
11. Three kinds of load work mode: purely light-operated, light-operated+time controlled,long-term on mode.

Panel figure

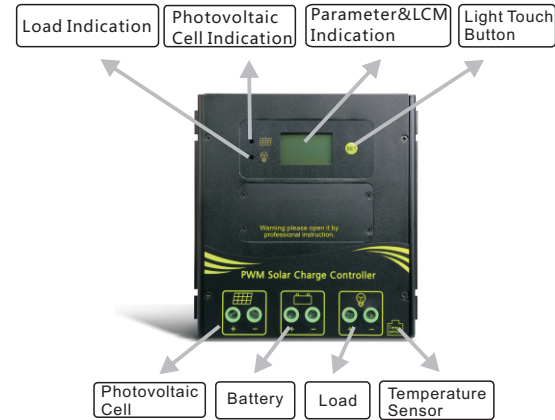

External And Installation Dimension

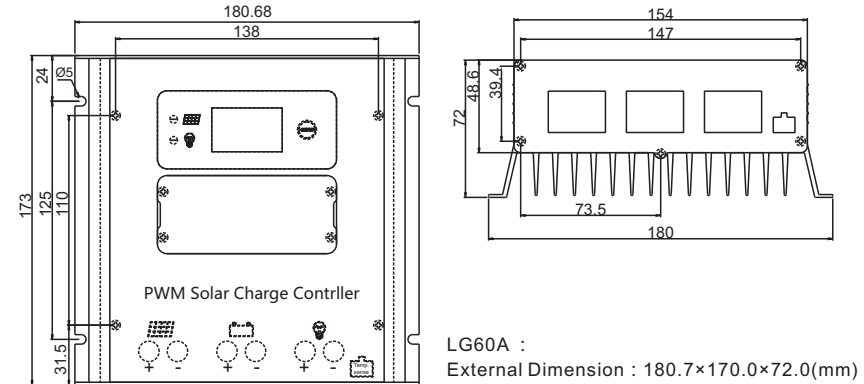

LG60A :
External Dimension : 180.7×170.0×72.0(mm)
Installation Dimension : 173.7×125(mm)

Model

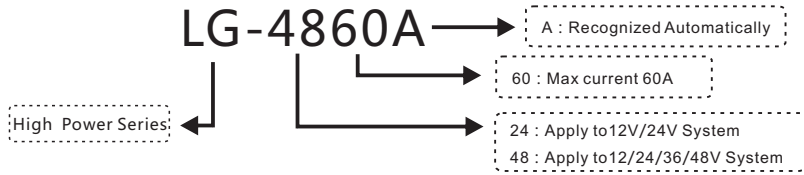

Connection Instruction

1. Preparation of the wire

Adopt the wire matching the current, plan the length of wire, strip 5mm insulation of one side of the controller's terminal and try to decrease the length of the connected wire so that a reduction in electrical loss.

2. Battery connection

Pay attention to the pole + , - , do not connect reversely. If connect correctly, the controller will start to work or it's necessary to check the wire connection and battery's situation. Users could connect the system followed by the order showed in the below figure.

3. Photovoltaic module connection

Pay attention to the pole + , - , if sun light is tested , photovoltaic indicator will light on or it's necessary to check the connection.

4. Load connection

Connect the load wire with the controller's output terminal, the current can't surpass the controller's rated current and pay attention to the + , - pole, for avoiding damage to the device ,do not connect reversely

5. Temperature sensor connection

Connect one side of the temperature sensor to controller, the other side to the battery. There must be a good thermal contact with the battery shell.

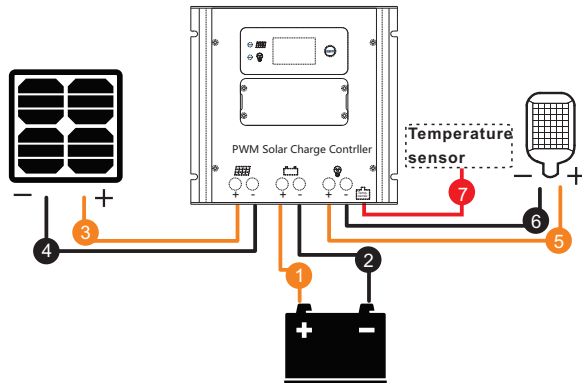

Attention : Connection according to the order showed in the upper figure

LCM Indication Instruction

The controller adopts segmentation LCM indicator which could show 7 items parameters

Overall Figure

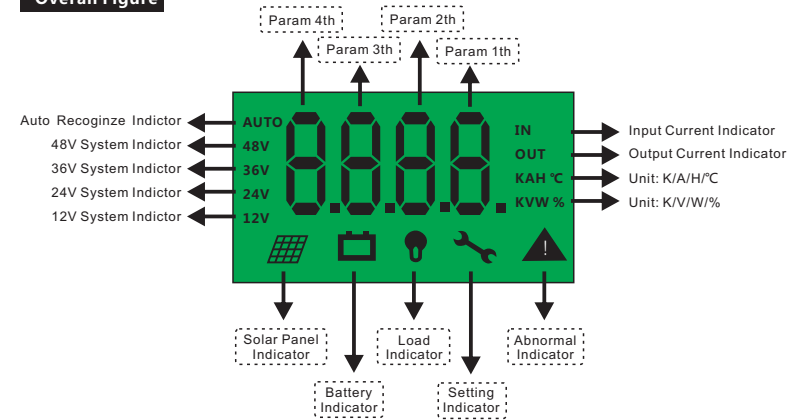

Displayed page

Screen initialize firstly then show kinds of system's parameters when power on.

1. Photovoltaic array current

This page shows the pv array real-time current

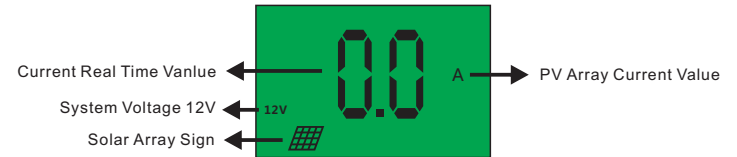

2. Battery voltage

This page show the real-time battery voltage

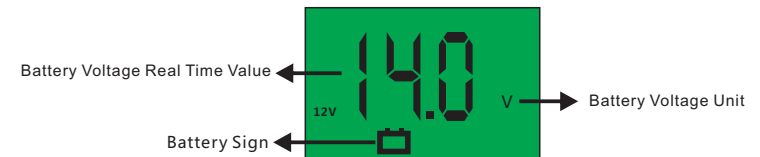

3. Load current

This page show the real-time load current

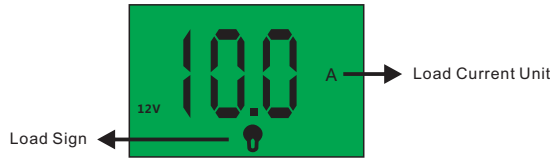

4. Battery temperature

This page show the real-time controller's inner temperature

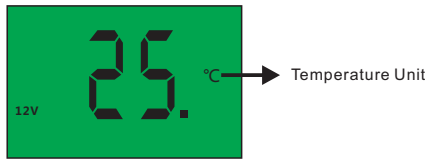

5. Charge power on the day

This page show the real-time charge power on the day

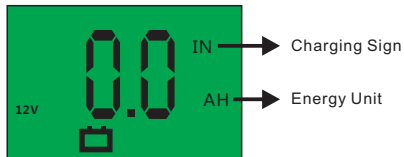

6. Discharge power on the day

This page show the real-time discharge power on the day

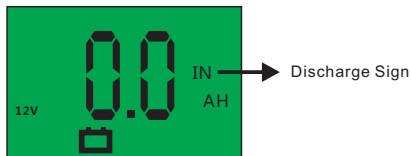

7. Word mode

This page show the real-time work mode

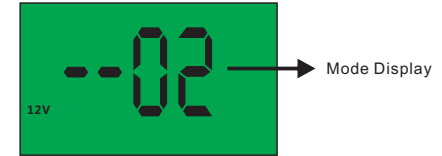

8. Fault warning

This page show the corresponding error code when system abnormal occurs, return to normal display after cancel the error

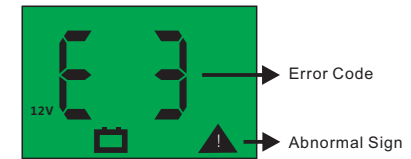

Mode operation and parameter browse

1. Parameter preview

Click the button : switch to next display page

Long press the button : long press the button in non-work mode page start the auto LCM switch display.

2. Working mode setting

Positioning the work mode page according to the "parameter preview"

Long press button : long-press in work page,click to user's required mode after the number blink, long-press for a period of time to exit with saving the parameter automatically, LCM switch to display again automatically after exit.

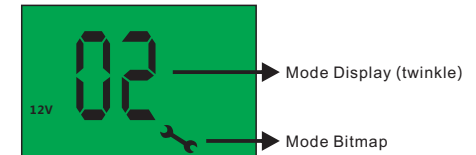

ATTENTION: switch automatically—It's not necessary to participate for users, LCM will switch to next page automatically every 3s.

Led Lattice panel

Led lattice panel adopt 5*5 lattice way. User can preview five running parameter of the controller in current also can adjusting the data by request. There is the smart anti-collision function for the parameter when adjusting to avoid the carelessness. This parameter viewed by coordinate.

Overall picture

The left side is the LED of parameter setting, the right side is the value of the LED parameter. As show 【Picture 13】

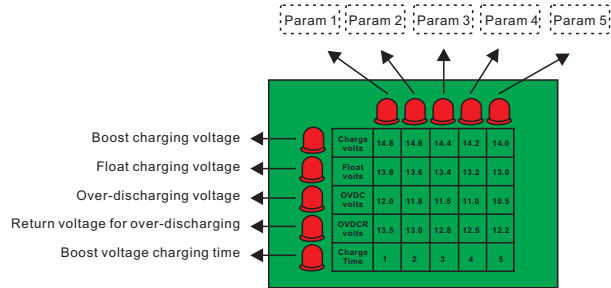

【Picture 13】

Operating instruction

1、Parameter preview

Short the key: The left parameter will switch to next parameter. The meaning of the parameter please refer to left of the "picture 13". The right of the "picture 13" show the Value. The result show as "picture 14", The crossing value of the up light and the left light is the corresponding value. The "picture 14" show the boost voltage is 14.2V.

2、Parameter setting

Please setting the parameter according to the "Parameter preview"

Long press the key: The left parameter is show the LED constant, the right side value will twinkle. Short press can switch to next value, long press or wait some minutes will save the use data automatically.

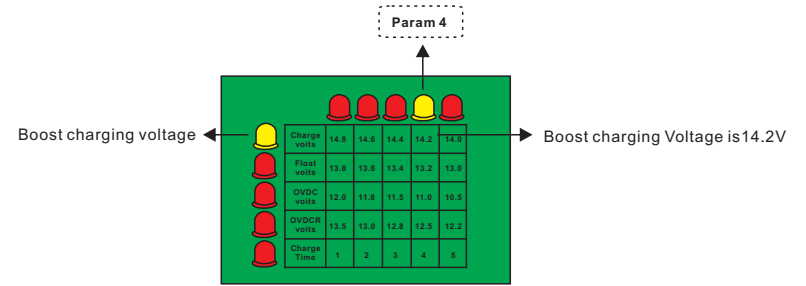

【Picture 14】

Parameter indication

Please kindly check the indication as below

	Param 1	Param 2	Param 3	Param 4	Param 5
Boost charging voltage (V)	14.8V	14.6V	14.4V	14.2V	14.0V
Float charging voltage (V)	13.8V	13.6V	13.4V	13.2V	13.0V
Over-discharging voltage (V)	12.0V	11.8V	11.5V	11.0V	10.5V
Return voltage for over-discharging (V)	13.5V	13.0V	12.8V	12.5V	12.2V
Boost voltage charging time (hour)	1H	2H	3H	4H	5H

Controller status

LED Light	Indications	Status	Functions
	Charging Indication	Always off	Night
		Always on	Daytime
		Twinkle slow	In charging
		Twinkle fast	System over voltage
	Load Indication	Always off	Load off
		Always on	Load on
		Twinkle slow	Overload
		Twinkle fast	Short circuit

System voltage alternative

If the model which voltage set by manual, before setting, please kindly check the system voltage. This controller support 12/24/36/48V system. Please choose the voltage before use

The model which voltage will recognized automatically, this dial switch not effect and the controller will recognize the battery voltage by itself.

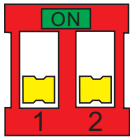

Truth Table		
System	Position	
12V	↓	↓
24V	↓	↑
36V	↑	↓
48V	↑	↑

System voltage	Dial switch state	Description
12v	Down Down	The right and left gear both turn to Upward.
24v	Down Up	Turn the left gear to Downward, Turn the right gear to Upward.
36V	Up Down	Turn the left gear to Upward, Turn the right gear to Downward
48V	Up Up	The right and left gear both turn to Upward.

Please setting firstly before running the system

System protection function description

1. Overtemperature protection

Controller temperature exceed 90°C will close the load and charging efficiency will decrease.

Temperature less than 85°C will recover.

Battery temperature exceed 55°C will close the load and charging will closed. Temperature less than 55°C will recover.

2. Charging protection

Decrease the charging efficiency when PV array charging current more than 60A and less then 1.25 times of 60A for 60s.

Decrease the charging efficiency when PV array charging current more than 1.25 and less then 1.5 times of 60A for 5s.

Decrease the charging efficiency when PV array charging current more than 1.5 times of 60A for 1s.

Recover after decrease charging efficiency for 1min.

3. Over discharge protection

The controller will start the over discharge protection and close the load when the battery voltage is less than over discharge voltage and duration 5s.

The controller will start the over discharge recovery protection when the battery voltage exceed the over discharge recovery voltage. The next night will remove automatically.

4. Short circuit protection

Short circuit:

The first time short circuit in one day will recover after 5s later.

The second time will recover after 10s later.

The third time will recover after 15s later.

The forth time will recover after 20s later.

The fifth time or more than five times will recover after 4hours later.

Also can recover by long press the key!

5. Over load protection

Over-load protection:

Close the load when load current more than 1 also less than 1.25 times of 60A for 60 seconds;

Close the load when load current more than 1.25 also less than 1.5 times of 60A for 30 seconds;

Close the load when load current more than 1.5 also less than 3 times of 60A for 5 seconds;

Recovery normal after overload stop 60s later, not have the limited times.

6. Reverse connection protection

This controller including the PV array, battery and load reverse connection protection.

Operating mode

LED Display	Mode	LED Display	Mode
00	Purely light-operated	08	Light-operated + time-controlled for 8 hours
01	Light-operated + time-controlled for 1 hour	09	Light-operated + time-controlled for 9 hours
02	Light-operated + time-controlled for 2 hours	10	Light-operated + time-controlled for 10 hours
03	Light-operated + time-controlled for 3 hours	11	Light-operated + time-controlled for 11 hours
04	Light-operated + time-controlled for 4 hours	12	Light-operated + time-controlled for 12 hours
05	Light-operated + time-controlled for 5 hours	13	Light-operated + time-controlled for 13 hour
06	Light-operated + time-controlled for 6 hours	14	Light-operated + time-controlled for 14 hours
07	Light-operated + time-controlled for 7 hours	15	Always on mode

Error instruction and description

Error code	Fault description	Solutions and recovery condition	LCM display	Led display
E1	Too high of controller temperature	Please ensure the solar panel and load power not exceeded the rate power then place the controller to ventilation environment. Auto recover after temperature decrease. Controller will decrease the charging efficiency and close discharge.	Bat and PV twinkle at the same time	---
E2	Battery over voltage	Please check right connection and voltage of the battery	Bat twinkle	Solar panel indicator twinkle fast
E3	Battery over discharge	Ensure the input voltage of the battery is normal. Recover auto after full charge	Bat twinkle	---
E4	Excessive charging current	Please check the solar panel power whether exceed the controller's rate power	Pv twinkle	---
E7	Load short circuit	Ensure the output line of the load not have short circuit. After eliminate the faults then long press the key or hold on it will recover automatically.	Load twinkle	Load indicator twinkle fast
E8	Overload	Please check the load power whether exceed the controller's rate power. After decrease the load then long press the key or hold on it will recover automatically.	Load twinkle	Load indicator twinkle slow
E9	Battery overheat	Please check the battery temperature overheat or not. Place the controller to ventilation environment. Controller will close charging and auto recover after temperature decrease.	Bat twinkle	Solar panel indicator twinkle fast

Accessories

Temperature probe	1pcs
Screwdriver.	1pcs
Instruction manual	1pcs

Parameters instruction

Parameter	Value	Adjustable	Default
System voltage	12V/24V/36V/48V	√	48V
Rate charging current	60A		
Rate discharging current	60A		
No load loss	<25mA		
Charging circuit voltage drop	Less or equal to 0.5V		
Discharge circuit voltage drop	Less or equal to 0.5V		
Solar input voltage	<140V		
Re-entrant boost charge mode voltage	13.2V; ×2/24V; ×3/36V; ×4/48V		
Over voltage protection	17.0V; ×2/24V; ×3/36V; ×4/48V		
limited voltage for charging	15.5V; ×2/24V; ×3/36V; ×4/48V		
Equal charging voltage	Boost charge voltage +0.5V		
Equal charging interval	30days		
Direct charge voltage	14.8V/14.6V/14.4V/14.2V/14.0V ×2/24V; ×3/36V; ×4/48V	√	14.4V
Float charge voltage	13.8V/13.6V/13.4V/13.2V/13.0V ×2/24V; ×3/36V; ×4/48V	√	13.8V
Over discharge voltage	12.0V/11.8V/11.5V/11.0V/10.5V ×2/24V; ×3/36V; ×4/48V	√	11.0V
Over discharge recover voltage	13.5V/13.0V/12.8V/12.5V/12.2V ×2/24V; ×3/36V; ×4/48V	√	12.5V
Lower voltage indication	Over discharge voltage +0.5V		
Equal charging time	1H		
Boost voltage charging time	1H-5H	√	2H
Temperature compensation	-3.0mv/°C/2V		
Light-control voltage	5V ×2/24V; ×3/36V; ×4/48V		
Light control delay	10min		
Controller over-temperature protection	>90°C		
Battery over-temperature protection	>55°C		
Working temperature	-35°C to +85°C		
Control method	Charging: PWM		
Time of lcd back- light auto shut down	30s		
Data auto transfer time	3S		
Time of Led lattice closed	25S		
Weight	1.28kg		
Dimensions	180.7×170.0×72.0(mm)		
Installation dimension	173.7×125(mm)		